



SH4

TYPE 4 SAFETY LIGHT CURTAINS

- Complete type 4 safety light curtains line
- Finger (14 mm), hand (30 mm), or body protection
- Improved performance and features
- Compact profile (35 x 40 mm)
- Wide range scalable in Basic, Standard and Advanced models
- Simultaneous muting and blanking
- Innovative wireless monitoring and configuration system
- Optical two beams synchronization and anti-interference coding
- Basic functions: alignment, automatic restart
- Standard functions: manual restart, EDM
- Standard Muting functions: 2-signals mono and bidirectional muting, override
- Advanced functions: partial muting, dynamic partial muting, 4-signals muting, reduced resolution, multiple fixed or floating blanking zones





CODE DESCRIPTION

SH 4 - 14 - 0300 - SM - 8 - 5

series	SH	Safety light curtain
type	4	Type 4
detection capability	14	Finger: 14 mm
	30	Hand: 30 mm
	2	Body: 2 Beams
	3	Body: 3 Beams
	4	Body: 4 Beams
monitored height	0300	300 mm
	0450	450 mm
	...	
	2250	2250 mm
functionality	B	Basic
	S	Standard
	SM	Standard muting
	A	Advanced
	C	Cascade
receiver main connector	5	5-pin male M12
	8	8-pin male M12
	12	12-pin male M12
		No connector
receiver secondary connector	5	5-pin female M12
		No connector

TECHNICAL FEATURES

	SH4-14-****-**-***	SH4-30-****-**-***
Protection	 finger	 hand
Type (EN61496-1)	4	
PL (EN ISO 13849-1)	e	
SIL (IEC 61508)	3	
Protected height	300...2250 mm (with 150 mm steps)	
Detection capability	14 mm	30 mm
Operating range	0.2 ... 10 m	0.2 ... 20 m
Operating distance using muting arms	0.5 ... 7 m	
Operating distance using reflective muting arms	0.5 ... 3 m	
Dead Zone	No dead zone	
Cascade connection	Up to 3 units	
Power supply (Vdc)	24 Vdc ± 20%	
Transmitter consumption	3.5 W max	
Receiver consumption	4.0 W max (without load)	
Safe Outputs	2 OSSD, with short circuit protection	
Auxiliary Outputs	2 PNP, with short circuit protection	
Output current	250 mA max / each output, 500 mA max total outputs	
Capacitive load	1 uF @ 24Vdc max	
Leakage current	< 1 mA	
Response time	from 12 to 30 ms (14 mm res)	from 10 to 19 ms (30 mm res)
Cables length	30 m	
Electrical protection	Class III	
Light source	Infrared LED (850 nm wavelength)	
Effective aperture angle (EAA)	< ± 2.5° at 3 m	
Operating temperature	-30 ... +55 °C	
Storage temperature	-30 ... +60 °C	
Temperature class	T6	
Humidity	15 ... 95 % (no condensation)	
Mechanical protection	IP65, IP 67 (EN 60529)	
Vibrations resistance	10 mm / 3 g, 5 ... 150 Hz frequency (EN 60068-2-6 / Class 3M7 IEC TR 60721-4-3)	
Shock resistance	25 g x 6 ms x 600 (EN 60068-2-27 / Class 3M7 IEC TR 60721-4-3)	
Weight	1.4 Kg/m (single bar, without package)	
Housing Material	Painted aluminium (yellow RAL 1003)	
Caps and covers material	PBT	
Window material	MAKROLON AR 7099 Clear PC	
Functions BASIC models (SH4-*-B-*)	Automatic Restart	
Functions STANDARD models (SH4-*-S-*)	Manual / Automatic Restart, Reset, External Device Monitoring (EDM), Alignment mode	
Functions STANDARD MUTING models (SH4-*-SM-*)	2-signals T Muting / L Muting, Muting dependent Override, Partial muting (half protection height), Muting input filtering and timeout setting, Anti-interference coding	
Functions ADVANCED models (SH4-*-A-*)	4-signals Muting, Dynamic muting, Partial Muting (at beams level), Fixed Blanking, External signal fixed blanking teach-in, Floating Blanking, Reduced resolution, Integrated pointer	
Functions CASCADE models (SH4-*-C-*)	Cascade models inherit the same functions of the main unit to which they are connected	
Configuration BASIC models (SH4-*-B-*) and STANDARD models (SH4-*-S-*)	By Wiring	
Configuration STANDARD MUTING models (SH4-*-SM-*)	By DIP-Switches	
Configuration ADVANCED models (SH4-*-A-*)	By DATASENSING SH4 DESIGNER and wi-fi connection	

	SH4-2-***-**-***-*	SH4-3-***-**-***-*	SH4-4-***-**-***-*
			
Protection	body		
Type (EN61496-1)	4		
PL (EN ISO 13849-1)	e		
SIL (IEC 61508)	3		
Protected height	500 mm	800 mm	900 or 1200 mm
Detection capability	500 mm	400 mm	300 or 400 mm
Operating range	Short range: 0.5 ... 15 m (default value); Long range: 5 ... 70 m (selectable)		
Operating distance using muting arms	0.5 ... 7 m		
Operating distance using reflective muting arms	0.5 ... 3 m		
Dead Zone	130 mm Distance from bottom to first beam		
Cascade connection	Not possible		
Power supply (Vdc)	24 Vdc ± 20%		
Transmitter consumption	3.5 W max		
Receiver consumption	4.0 W max (without load)		
Safe Outputs	2 OSSD, with short circuit protection		
Auxiliary Outputs	2 PNP, with short circuit protection		
Output current	250 mA max / each output, 500 mA max total outputs		
Capacitive load	1 uF @ 24Vdc max		
Leakage current	< 1 mA		
Response time	from 12 to 15 ms		
Cables length	30 m receiver; 50 m transmitter		
Electrical protection	Class III		
Light source	Infrared LED (850 nm wavelength)		
Effective aperture angle (EAA)	< ± 2.5° at 3 m		
Operating temperature	-30 ... +55 °C		
Storage temperature	-30 ... +60 °C		
Temperature class	T6		
Humidity	15 ... 95 % (no condensation)		
Mechanical protection	IP65, IP 67 (EN 60529)		
Vibrations resistance	10 mm / 3 g, 5 ... 150 Hz frequency (EN 60068-2-6 / Class 3M7 IEC TR 60721-4-3)		
Shock resistance	25 g x 6 ms x 600 (EN 60068-2-27 / Class 3M7 IEC TR 60721-4-3)		
Weight	1.4 Kg/m (single bar, without package)		
Housing Material	Painted aluminium (yellow RAL 1003)		
Caps and covers material	PBT		
Window material	MAKROLON AR 7099 Clear PC		
Functions BASIC models (SH4-*-B-*)	Automatic Restart		
Functions STANDARD models (SH4-*-S-*)	Manual / Automatic Restart, Reset, External Device Monitoring (EDM), Alignment mode		
Functions STANDARD MUTING models (SH4-*-SM-*)	2-signals T Muting / L Muting, Muting dependent Override, Partial muting (half protection height), Muting input filtering and timeout setting, Anti-interference coding		
Functions ADVANCED models (SH4-*-A-*)	4-signals Muting, Dynamic partial muting, Partial Muting (at beams level), integrated pointer		
Functions CASCADE models (SH4-*-C-*)	Cascade models inherit the same functions of the main unit to which they are connected		
Configuration BASIC models (SH4-*-B-*) and STANDARD models (SH4-*-S-*)	By Wiring		
Configuration STANDARD MUTING models (SH4-*-SM-*)	By DIP-Switches		
Configuration ADVANCED models (SH4-*-A-*)	By DATASENSING SH4 DESIGNER and wi-fi connection		

AVAILABLE MODELS

Capability	Range	Functionality	Receiver connector	Protected height (mm)	beams	Response time (ms) with Anti-Interference code disabled	Response time (ms) with Anti-Interference code enabled	Model
14 mm	0.2... 10 m	basic	5 poles	300	30	9	14	SH4-14-0300-B-5 (957920001)
				450	45	10	18	SH4-14-0450-B-5 (957920002)
				600	60	12	22	SH4-14-0600-B-5 (957920003)
				750	75	13	26	SH4-14-0750-B-5 (957920004)
				900	90	15	30	SH4-14-0900-B-5 (957920005)
				1050	105	16	33	SH4-14-1050-B-5 (957920006)
				1200	120	18	37	SH4-14-1200-B-5 (957920007)
				1350	135	20	41	SH4-14-1350-B-5 (957920008)
				1500	150	21	45	SH4-14-1500-B-5 (957920009)
				1650	165	23	49	SH4-14-1650-B-5 (957920010)
				1800	180	24	52	SH4-14-1800-B-5 (957920011)
				1950	195	26	56	SH4-14-1950-B-5 (957920012)
				2100	210	27	60	SH4-14-2100-B-5 (957920013)
2250	225	29	64	SH4-14-2250-B-5 (957920014)				
14 mm	0.2... 10 m	standard	8 poles	300	30	9	14	SH4-14-0300-S-8 (957920015)
				450	45	10	18	SH4-14-0450-S-8 (957920016)
				600	60	12	22	SH4-14-0600-S-8 (957920017)
				750	75	13	26	SH4-14-0750-S-8 (957920018)
				900	90	15	30	SH4-14-0900-S-8 (957920019)
				1050	105	16	33	SH4-14-1050-S-8 (957920020)
				1200	120	18	37	SH4-14-1200-S-8 (957920021)
				1350	135	20	41	SH4-14-1350-S-8 (957920022)
				1500	150	21	45	SH4-14-1500-S-8 (957920023)
				1650	165	23	49	SH4-14-1650-S-8 (957920024)
				1800	180	24	52	SH4-14-1800-S-8 (957920025)
				1950	195	26	56	SH4-14-1950-S-8 (957920026)
				2100	210	27	60	SH4-14-2100-S-8 (957920027)
2250	225	29	64	SH4-14-2250-S-8 (957920028)				

For units in cascade, the overall response time is given by this formula. 2 units: (sum of units response time + 1 ms); 3 units: (sum of units response time - 1 ms)

Capability	Range	Functionality	Receiver connector	Protected height (mm)	beams	Response time (ms) with Anti-Interference code disabled	Response time (ms) with Anti-Interference code enabled	Model
14 mm	0.2... 10 m	standard muting	8 poles	300	30	9	14	SH4-14-0300-SM-8 (957920043)
				450	45	10	18	SH4-14-0450-SM-8 (957920044)
				600	60	12	22	SH4-14-0600-SM-8 (957920045)
				750	75	13	26	SH4-14-0750-SM-8 (957920046)
				900	90	15	30	SH4-14-0900-SM-8 (957920047)
				1050	105	16	33	SH4-14-1050-SM-8 (957920048)
				1200	120	18	37	SH4-14-1200-SM-8 (957920049)
				1350	135	20	41	SH4-14-1350-SM-8 (957920050)
				1500	150	21	45	SH4-14-1500-SM-8 (957920051)
				1650	165	23	49	SH4-14-1650-SM-8 (957920052)
				1800	180	24	52	SH4-14-1800-SM-8 (957920053)
				1950	195	26	56	SH4-14-1950-SM-8 (957920054)
				2100	210	27	60	SH4-14-2100-SM-8 (957920055)
				2250	225	29	64	SH4-14-2250-SM-8 (957920056)
14 mm	0.2... 10 m	standard muting	8 and 5 poles	300	30	9	14	SH4-14-0300-SM-8-5 (957920565)
				450	45	10	18	SH4-14-0450-SM-8-5 (957920566)
				600	60	12	22	SH4-14-0600-SM-8-5 (957920567)
				750	75	13	26	SH4-14-0750-SM-8-5 (957920568)
				900	90	15	30	SH4-14-0900-SM-8-5 (957920569)
				1050	105	16	33	SH4-14-1050-SM-8-5 (957920570)
				1200	120	18	37	SH4-14-1200-SM-8-5 (957920571)
				1350	135	20	41	SH4-14-1350-SM-8-5 (957920572)
				1500	150	21	45	SH4-14-1500-SM-8-5 (957920573)
				1650	165	23	49	SH4-14-1650-SM-8-5 (957920574)
				1800	180	24	52	SH4-14-1800-SM-8-5 (957920575)
				1950	195	26	56	SH4-14-1950-SM-8-5 (957920576)
				2100	210	27	60	SH4-14-2100-SM-8-5 (957920577)
				2250	225	29	64	SH4-14-2250-SM-8-5 (957920578)

For units in cascade, the overall response time is given by this formula. 2 units: (sum of units response time + 1 ms); 3 units: (sum of units response time - 1 ms)

Capability	Range	Functionality	Receiver connector	Protected height (mm)	beams	Response time (ms) with Anti-Interference code disabled	Response time (ms) with Anti-Interference code enabled	Model
14 mm	0.2 ... 10 m	advanced	12 poles	300	30	9	14	SH4-14-0300-A-12 (957920147)
				450	45	10	18	SH4-14-0450-A-12 (957920148)
				600	60	12	22	SH4-14-0600-A-12 (957920149)
				750	75	13	26	SH4-14-0750-A-12 (957920150)
				900	90	15	30	SH4-14-0900-A-12 (957920151)
				1050	105	16	33	SH4-14-1050-A-12 (957920152)
				1200	120	18	37	SH4-14-1200-A-12 (957920153)
				1350	135	20	41	SH4-14-1350-A-12 (957920154)
				1500	150	21	45	SH4-14-1500-A-12 (957920155)
				1650	165	23	49	SH4-14-1650-A-12 (957920156)
				1800	180	24	52	SH4-14-1800-A-12 (957920157)
				1950	195	26	56	SH4-14-1950-A-12 (957920158)
				2100	210	27	60	SH4-14-2100-A-12 (957920159)
2250	225	29	64	SH4-14-2250-A-12 (957920160)				
14 mm	0.2 ... 10 m	advanced	12 and 5 poles	300	30	9	14	SH4-14-0300-A-12-5 (957920161)
				450	45	10	18	SH4-14-0450-A-12-5 (957920162)
				600	60	12	22	SH4-14-0600-A-12-5 (957920163)
				750	75	13	26	SH4-14-0750-A-12-5 (957920164)
				900	90	15	30	SH4-14-0900-A-12-5 (957920165)
				1050	105	16	33	SH4-14-1050-A-12-5 (957920166)
				1200	120	18	37	SH4-14-1200-A-12-5 (957920167)
				1350	135	20	41	SH4-14-1350-A-12-5 (957920168)
				1500	150	21	45	SH4-14-1500-A-12-5 (957920169)
				1650	165	23	49	SH4-14-1650-A-12-5 (957920170)
				1800	180	24	52	SH4-14-1800-A-12-5 (957920171)
				1950	195	26	56	SH4-14-1950-A-12-5 (957920172)
				2100	210	27	60	SH4-14-2100-A-12-5 (957920173)
2250	225	29	64	SH4-14-2250-A-12-5 (957920174)				

For units in cascade, the overall response time is given by this formula. 2 units: (sum of units response time + 1 ms); 3 units: (sum of units response time - 1 ms)

Capability	Range	Functionality	Receiver connector	Protected height (mm)	beams	Response time (ms) with Anti-Interference code disabled	Response time (ms) with Anti-Interference code enabled	Model
14 mm	0.2 ... 10 m	cascade	5 and 5 poles	300	30	9	14	SH4-14-0300-C-5-5 (957920029)
				450	45	10	18	SH4-14-0450-C-5-5 (957920030)
				600	60	12	22	SH4-14-0600-C-5-5 (957920031)
				750	75	13	26	SH4-14-0750-C-5-5 (957920032)
				900	90	15	30	SH4-14-0900-C-5-5 (957920033)
				1050	105	16	33	SH4-14-1050-C-5-5 (957920034)
				1200	120	18	37	SH4-14-1200-C-5-5 (957920035)
				1350	135	20	41	SH4-14-1350-C-5-5 (957920036)
				1500	150	21	45	SH4-14-1500-C-5-5 (957920037)
				1650	165	23	49	SH4-14-1650-C-5-5 (957920038)
				1800	180	24	52	SH4-14-1800-C-5-5 (957920039)
				1950	195	26	56	SH4-14-1950-C-5-5 (957920040)
				2100	210	27	60	SH4-14-2100-C-5-5 (957920041)
				2250	225	29	64	SH4-14-2250-C-5-5 (957920042)
30 mm	0.2 ... 20 m	basic	5 poles	300	12	7	10	SH4-30-0300-B-5 (957920057)
				450	18	8	12	SH4-30-0450-B-5 (957920058)
				600	24	9	13	SH4-30-0600-B-5 (957920059)
				750	30	9	15	SH4-30-0750-B-5 (957920060)
				900	36	10	17	SH4-30-0900-B-5 (957920061)
				1050	42	11	18	SH4-30-1050-B-5 (957920062)
				1200	48	12	20	SH4-30-1200-B-5 (957920063)
				1350	54	12	22	SH4-30-1350-B-5 (957920064)
				1500	60	13	23	SH4-30-1500-B-5 (957920065)
				1650	66	14	25	SH4-30-1650-B-5 (957920066)
				1800	72	14	27	SH4-30-1800-B-5 (957920067)
				1950	78	15	28	SH4-30-1950-B-5 (957920068)
				2100	84	16	30	SH4-30-2100-B-5 (957920069)
				2250	90	17	32	SH4-30-2250-B-5 (957920070)

For units in cascade, the overall response time is given by this formula. 2 units: (sum of units response time + 1 ms); 3 units: (sum of units response time - 1 ms)

Capability	Range	Functionality	Receiver connector	Protected height (mm)	beams	Response time (ms) with Anti-Interference code disabled	Response time (ms) with Anti-Interference code enabled	Model
30 mm	0.2 ... 20 m	standard	8 poles	300	12	7	10	SH4-30-0300-S-8 (957920071)
				450	18	8	12	SH4-30-0450-S-8 (957920072)
				600	24	9	13	SH4-30-0600-S-8 (957920073)
				750	30	9	15	SH4-30-0750-S-8 (957920074)
				900	36	10	17	SH4-30-0900-S-8 (957920075)
				1050	42	11	18	SH4-30-1050-S-8 (957920076)
				1200	48	12	20	SH4-30-1200-S-8 (957920077)
				1350	54	12	22	SH4-30-1350-S-8 (957920078)
				1500	60	13	23	SH4-30-1500-S-8 (957920079)
				1650	66	14	25	SH4-30-1650-S-8 (957920080)
				1800	72	14	27	SH4-30-1800-S-8 (957920081)
				1950	78	15	28	SH4-30-1950-S-8 (957920082)
				2100	84	16	30	SH4-30-2100-S-8 (957920083)
				2250	90	17	32	SH4-30-2250-S-8 (957920084)
30 mm	0.2 ... 20 m	standard muting	8 poles	300	12	7	10	SH4-30-0300-SM-8 (957920099)
				450	18	8	12	SH4-30-0450-SM-8 (957920100)
				600	24	9	13	SH4-30-0600-SM-8 (957920101)
				750	30	9	15	SH4-30-0750-SM-8 (957920102)
				900	36	10	17	SH4-30-0900-SM-8 (957920103)
				1050	42	11	18	SH4-30-1050-SM-8 (957920104)
				1200	48	12	20	SH4-30-1200-SM-8 (957920105)
				1350	54	12	22	SH4-30-1350-SM-8 (957920106)
				1500	60	13	23	SH4-30-1500-SM-8 (957920107)
				1650	66	14	25	SH4-30-1650-SM-8 (957920108)
				1800	72	14	27	SH4-30-1800-SM-8 (957920109)
				1950	78	15	28	SH4-30-1950-SM-8 (957920110)
				2100	84	16	30	SH4-30-2100-SM-8 (957920111)
				2250	90	17	32	SH4-30-2250-SM-8 (957920112)

For units in cascade, the overall response time is given by this formula. 2 units: (sum of units response time + 1 ms); 3 units: (sum of units response time - 1 ms)

Capability	Range	Functionality	Receiver connector	Protected height (mm)	beams	Response time (ms) with Anti-Interference code disabled	Response time (ms) with Anti-Interference code enabled	Model
30 mm	0.2 ... 20 m	standard muting	8 and 5 poles	300	12	7	10	SH4-30-0300-SM-8-5 (957920085)
				450	18	8	12	SH4-30-0450-SM-8-5 (957920086)
				600	24	9	13	SH4-30-0600-SM-8-5 (957920087)
				750	30	9	15	SH4-30-0750-SM-8-5 (957920088)
				900	36	10	17	SH4-30-0900-SM-8-5 (957920089)
				1050	42	11	18	SH4-30-1050-SM-8-5 (957920090)
				1200	48	12	20	SH4-30-1200-SM-8-5 (957920091)
				1350	54	12	22	SH4-30-1350-SM-8-5 (957920092)
				1500	60	13	23	SH4-30-1500-SM-8-5 (957920093)
				1650	66	14	25	SH4-30-1650-SM-8-5 (957920094)
				1800	72	14	27	SH4-30-1800-SM-8-5 (957920095)
				1950	78	15	28	SH4-30-1950-SM-8-5 (957920096)
				2100	84	16	30	SH4-30-2100-SM-8-5 (957920097)
				2250	90	17	32	SH4-30-2250-SM-8-5 (957920098)
30 mm	0.2 ... 20 m	advanced	12 poles	300	12	7	10	SH4-30-0300-A-12 (957920189)
				450	18	8	12	SH4-30-0450-A-12 (957920190)
				600	24	9	13	SH4-30-0600-A-12 (957920191)
				750	30	9	15	SH4-30-0750-A-12 (957920192)
				900	36	10	17	SH4-30-0900-A-12 (957920193)
				1050	42	11	18	SH4-30-1050-A-12 (957920194)
				1200	48	12	20	SH4-30-1200-A-12 (957920195)
				1350	54	12	22	SH4-30-1350-A-12 (957920196)
				1500	60	13	23	SH4-30-1500-A-12 (957920197)
				1650	66	14	25	SH4-30-1650-A-12 (957920198)
				1800	72	14	27	SH4-30-1800-A-12 (957920199)
				1950	78	15	28	SH4-30-1950-A-12 (957920200)
				2100	84	16	30	SH4-30-2100-A-12 (957920201)
				2250	90	17	32	SH4-30-2250-A-12 (957920202)

For units in cascade, the overall response time is given by this formula. 2 units: (sum of units response time + 1 ms); 3 units: (sum of units response time - 1 ms)







Capability	Range	Functionality	Receiver connector	Protected height (mm)	beams	Response time (ms) with Anti-Interference code disabled	Response time (ms) with Anti-Interference code enabled	Model
30 mm	0.2 ... 20 m	advanced	5 and 12 poles	300	12	7	10	SH4-30-0300-A-12-5 (957920203)
				450	18	8	12	SH4-30-0450-A-12-5 (957920204)
				600	24	9	13	SH4-30-0600-A-12-5 (957920205)
				750	30	9	15	SH4-30-0750-A-12-5 (957920206)
				900	36	10	17	SH4-30-0900-A-12-5 (957920207)
				1050	42	11	18	SH4-30-1050-A-12-5 (957920208)
				1200	48	12	20	SH4-30-1200-A-12-5 (957920209)
				1350	54	12	22	SH4-30-1350-A-12-5 (957920210)
				1500	60	13	23	SH4-30-1500-A-12-5 (957920211)
				1650	66	14	25	SH4-30-1650-A-12-5 (957920212)
				1800	72	14	27	SH4-30-1800-A-12-5 (957920213)
				1950	78	15	28	SH4-30-1950-A-12-5 (957920214)
				2100	84	16	30	SH4-30-2100-A-12-5 (957920215)
				2250	90	17	32	SH4-30-2250-A-12-5 (957920216)
30 mm	0.2 ... 20 m	cascade	5 and 5 poles	300	12	7	10	SH4-30-0300-C-5-5 (957920113)
				450	18	8	12	SH4-30-0450-C-5-5 (957920114)
				600	24	9	13	SH4-30-0600-C-5-5 (957920115)
				750	30	9	15	SH4-30-0750-C-5-5 (957920116)
				900	36	10	17	SH4-30-0900-C-5-5 (957920117)
				1050	42	11	18	SH4-30-1050-C-5-5 (957920118)
				1200	48	12	20	SH4-30-1200-C-5-5 (957920119)
				1350	54	12	22	SH4-30-1350-C-5-5 (957920120)
				1500	60	13	23	SH4-30-1500-C-5-5 (957920121)
				1650	66	14	25	SH4-30-1650-C-5-5 (957920122)
				1800	72	14	27	SH4-30-1800-C-5-5 (957920123)
				1950	78	15	28	SH4-30-1950-C-5-5 (957920124)
				2100	84	16	30	SH4-30-2100-C-5-5 (957920125)
				2250	90	17	32	SH4-30-2250-C-5-5 (957920126)

For units in cascade, the overall response time is given by this formula. 2 units: (sum of units response time + 1 ms); 3 units: (sum of units response time - 1 ms)

Capability	Range	Functionality	Receiver connector	Protected height (mm)	beams	Response time (ms) with Anti-Interference code disabled	Response time (ms) with Anti-Interference code enabled	Model
body detection	0.5 ... 70 m	basic	5 poles	500	2	12	23	SH4-2-0500-B-5 (957920127)
				800	3	15	27	SH4-3-0800-B-5 (957920128)
				900	4	15	29	SH4-4-0900-B-5 (957920129)
				1200	4	15	29	SH4-4-1200-B-5 (957920130)
		standard	8 poles	500	2	12	23	SH4-2-0500-S-8 (957920131)
				800	3	15	27	SH4-3-0800-S-8 (957920132)
				900	4	15	29	SH4-4-0900-S-8 (957920133)
				1200	4	15	29	SH4-4-1200-S-8 (957920134)
		standard muting	8 poles	500	2	12	23	SH4-2-0500-SM-8 (957920139)
				800	3	15	27	SH4-3-0800-SM-8 (957920140)
				900	4	15	29	SH4-4-0900-SM-8 (957920141)
				1200	4	15	29	SH4-4-1200-SM-8 (957920142)
		standard muting	8 and 5 poles	500	2	12	23	SH4-2-0500-SM-8-5 (957920135)
				800	3	15	27	SH4-3-0800-SM-8-5 (957920136)
				900	4	15	29	SH4-4-0900-SM-8-5 (957920137)
				1200	4	15	29	SH4-4-1200-SM-8-5 (957920138)
		advanced	12 and 5 poles	500	2	12	23	SH4-2-0500-A-12-5 (957920231)
				800	3	15	27	SH4-3-0800-A-12-5 (957920232)
				900	4	15	29	SH4-4-0900-A-12-5 (957920233)
				1200	4	15	29	SH4-4-1200-A-12-5 (957920234)

For units in cascade, the overall response time is given by this formula. 2 units: (sum of units response time + 1 ms); 3 units: (sum of units response time - 1 ms)

CONNECTION DIAGRAMS (RECEIVER MAIN CONNECTOR)

SH4 BASE (SH4-**-****-B-xx-5): M12 male 5-poles		SH4 STANDARD (SH4-**-****-S-8): M12 male 8-poles	
	<p>1 — BROWN — 24 Vdc — POWER</p> <p>2 — WHITE — 0 Vdc — SAFE OUTPUT</p> <p>3 — BLUE — COM — POWER</p> <p>4 — BLACK — OSSD2 — SAFE OUTPUT</p> <p>5 — GREY — COM — COM</p>		<p>1 — WHITE — RESTART/RESET — INPUT</p> <p>2 — BROWN — 24Vdc — POWER</p> <p>3 — GREEN — EDM / SELECTION — INPUT</p> <p>4 — YELLOW — EDM — INPUT</p> <p>5 — GREY — OSSD1 — SAFE OUTPUT</p> <p>6 — PINK — OSSD2 — SAFE OUTPUT</p> <p>7 — BLUE — 0 Vdc — POWER</p> <p>8 — RED — MAN/AUTO SELECTION — INPUT</p>
SH4 STANDARD MUTING (SH4-**-****-SM-8): M12 male 8-poles		SH4 STANDARD MUTING (SH4-**-****-S-8-5): M12 male 8-poles	
	<p>1 — WHITE — RESTART/RESET/EDM/OVERRIDE — INPUT</p> <p>2 — BROWN — 24Vdc — POWER</p> <p>3 — GREEN — MUTING1 — INPUT</p> <p>4 — YELLOW — MUTING2 — INPUT</p> <p>5 — GREY — OSSD1 — SAFE OUTPUT</p> <p>6 — PINK — OSSD2 — SAFE OUTPUT</p> <p>7 — BLUE — 0 Vdc — POWER</p> <p>8 — RED — MUTING LAMP — OUTPUT</p>		<p>1 — WHITE — RESTART/RESET — INPUT</p> <p>2 — BROWN — 24Vdc — POWER</p> <p>3 — GREEN — EDM / SELECTION — INPUT</p> <p>4 — YELLOW — EDM — INPUT</p> <p>5 — GREY — OSSD1 — SAFE OUTPUT</p> <p>6 — PINK — OSSD2 — SAFE OUTPUT</p> <p>7 — BLUE — 0 Vdc — POWER</p> <p>8 — RED — OVRER-RIDE 2 — INPUT</p>
SH4 ADVANCED (SH4-**-****-A-12): M12 male 12-poles		SH4 ADVANCED (SH4-**-****-A-12-5): M12 male 12-poles	
	<p>1 — BROWN — 24 Vdc — POWER</p> <p>2 — BLUE — 0 Vdc — POWER</p> <p>3 — WHITE — CONFIGURABLE INPUT — INPUT</p> <p>4 — GREEN — CONFIGURABLE INPUT — INPUT</p> <p>5 — PINK — OSSD2 — SAFE OUTPUT</p> <p>6 — YELLOW — CONFIGURABLE INPUT — INPUT</p> <p>7 — BLACK — CONFIGURABLE INPUT/OUTPUT — INPUT/OUTPUT</p> <p>8 — GREY — OSSD1 — SAFE OUTPUT</p> <p>9 — RED — CONFIGURABLE INPUT — INPUT</p> <p>10 — VIOLET — CONFIGURABLE INPUT/OUTPUT — INPUT/OUTPUT</p> <p>11 — GREY/PINK — OVRER-RIDE 2 — OUTPUT</p> <p>12 — RED/BLUE — CONFIGURABLE INPUT — INPUT</p>		<p>1 — BROWN — 24 Vdc — POWER</p> <p>2 — BLUE — 0 Vdc — POWER</p> <p>3 — WHITE — CONFIGURABLE INPUT — INPUT</p> <p>4 — GREEN — CONFIGURABLE INPUT — INPUT</p> <p>5 — PINK — OSSD2 — SAFE OUTPUT</p> <p>6 — YELLOW — CONFIGURABLE INPUT — INPUT</p> <p>7 — BLACK — CONFIGURABLE INPUT — INPUT</p> <p>8 — GREY — OSSD1 — SAFE OUTPUT</p> <p>9 — RED — OVRER-RIDE 2 — INPUT</p> <p>10 — VIOLET — CONFIGURABLE INPUT/OUTPUT — INPUT/OUTPUT</p> <p>11 — GREY/PINK — CONFIGURABLE INPUT/OUTPUT — INPUT/OUTPUT</p> <p>12 — RED/BLUE — N/A</p>

NOTES:

Inputs and Outputs of SH4 ADVANCED can be reconfigured with DATASENSING SH4 DESIGNER APP between the following:

INPUTS				OUTPUTS	
• Reset	• EDM	• Muting3	• Override1	• Lamp	
• Restart	• Muting1	• Muting4	• Teach in		• Override status
• Align	• Muting2	• Muting Enable	• Beam Tolerance		

CONNECTION DIAGRAMS (RECEIVER SECONDARY CONNECTOR)

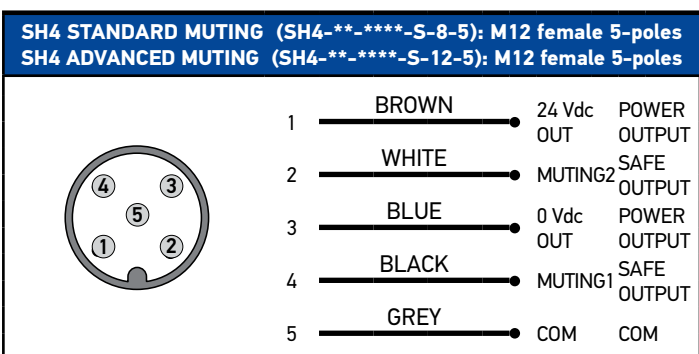

CONNECTION DIAGRAMS (TRANSMITTER MAIN CONNECTOR)

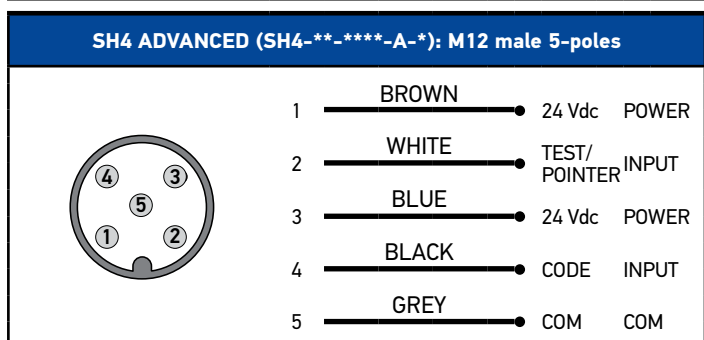
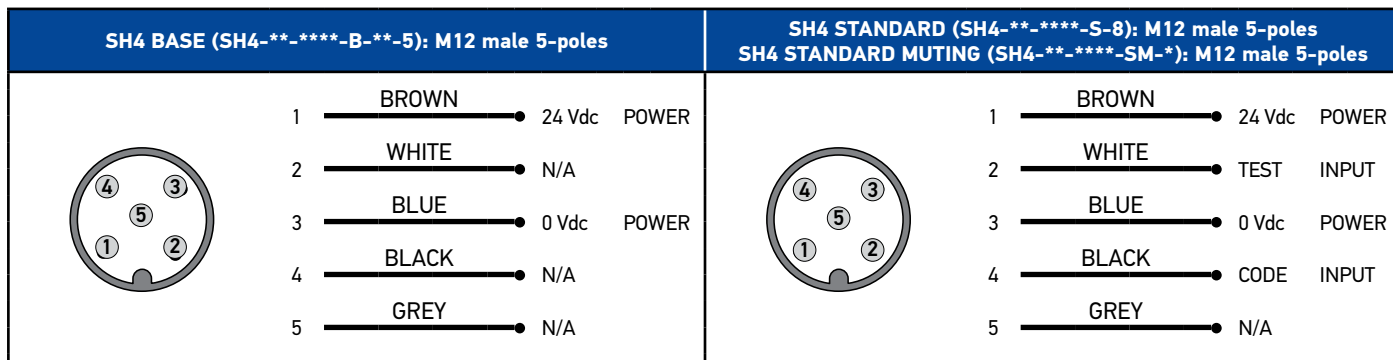

CONNECTION DIAGRAMS (TRANSMITTER SECONDARY CONNECTOR)

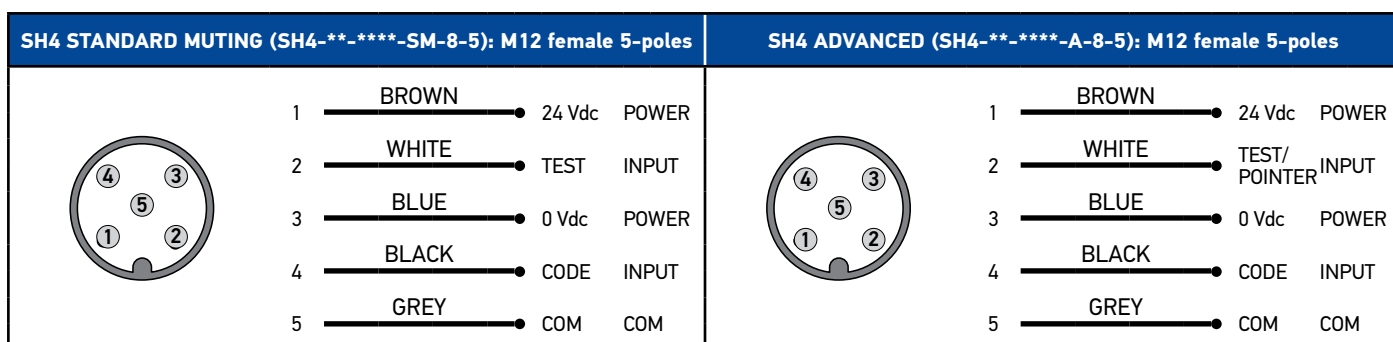

NOTE: PIN2 on transmitter main connector of body resolution models (SH4-2/3/4-*-**) can be used for selection of short or long range.

DIMENSIONS (FINGER)

SH4-14-***-**-**		Model	L (mm)
		SH4-14-0300-***-**	309
		SH4-14-0450-***-**	459
		SH4-14-0600-***-**	609
		SH4-14-0750-***-**	759
		SH4-14-0900-***-**	909
		SH4-14-1050-***-**	1059
		SH4-14-1200-***-**	1209
		SH4-14-1300-***-**	1359
		SH4-14-1500-***-**	1509
		SH4-14-1650-***-**	1659
		SH4-14-1800-***-**	1809
		SH4-14-1950-***-**	1959
		SH4-14-2100-***-**	2109
		SH4-14-2250-***-**	2259
		SH4-14-2400-***-**	2409
		SH4-14-2550-***-**	2559
		SH4-14-2700-***-**	2709
		SH4-14-2850-***-**	2859
	SH4-14-3000-***-**	3009	

(mm)

DIMENSIONS (HAND)

SH30-30-***-**-**		Model	L (mm)
		SH4-30-0300-***-**	309
		SH4-30-0450-***-**	459
		SH4-30-0600-***-**	609
		SH4-30-0750-***-**	759
		SH4-30-0900-***-**	909
		SH4-30-1050-***-**	1059
		SH4-30-1200-***-**	1209
		SH4-30-1300-***-**	1359
		SH4-30-1500-***-**	1509
		SH4-30-1650-***-**	1659
		SH4-30-1800-***-**	1809
		SH4-30-1950-***-**	1959
		SH4-30-2100-***-**	2109
		SH4-30-2250-***-**	2259
		SH4-30-2400-***-**	2409
		SH4-30-2550-***-**	2559
		SH4-30-2700-***-**	2709
		SH4-30-2850-***-**	2859
	SH4-30-3000-***-**	3009	

(mm)

DIMENSIONS (BODY)

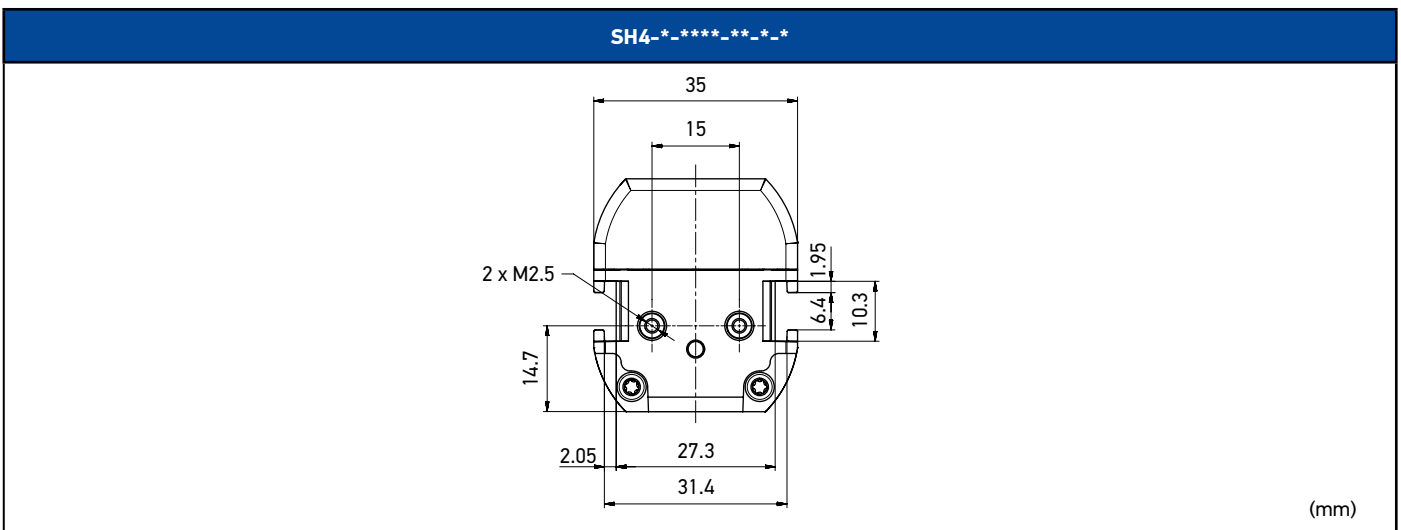
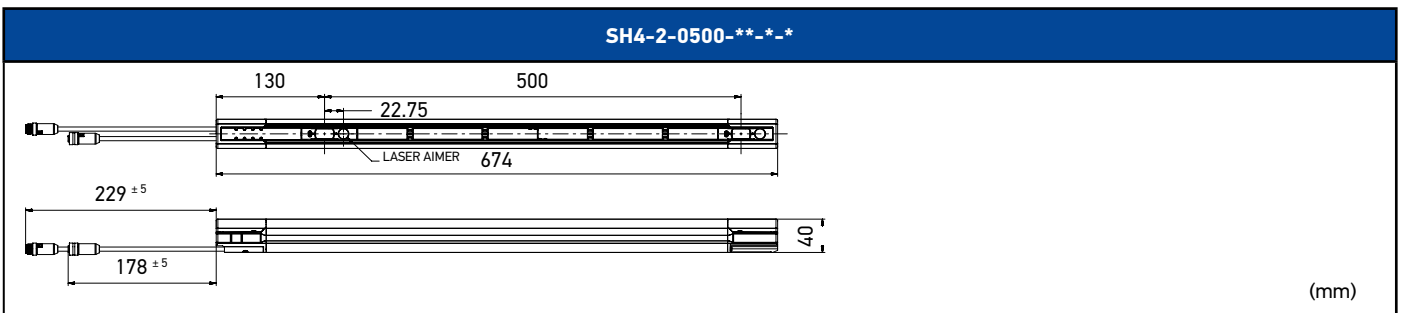
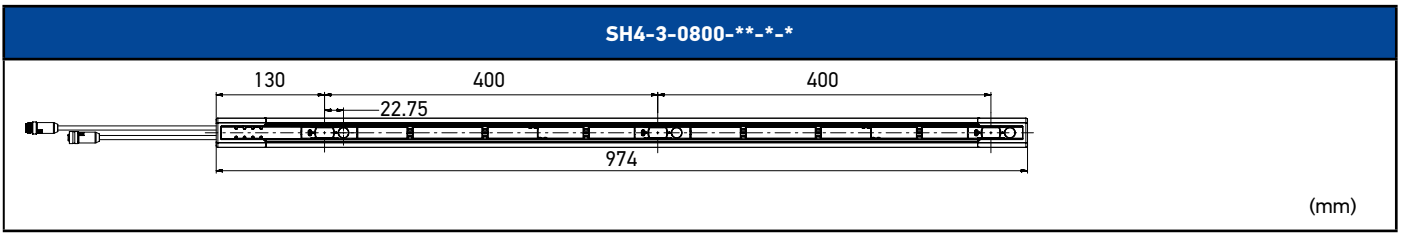
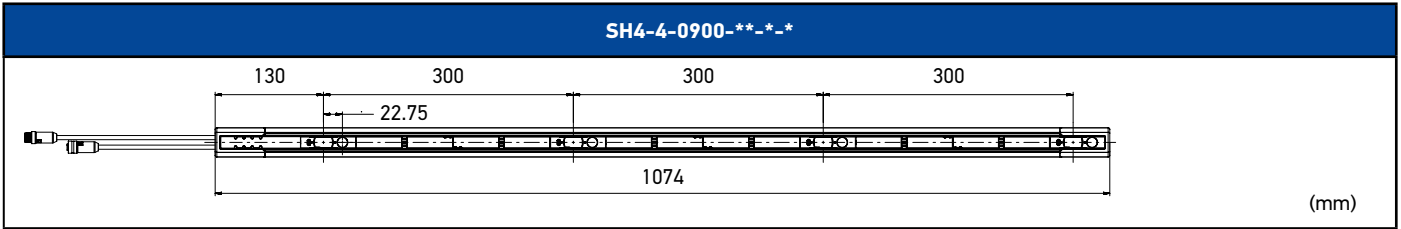
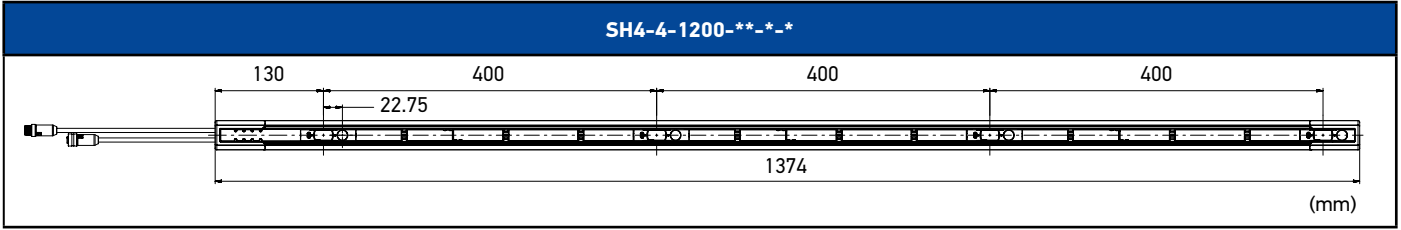

ACCESSORIES: BRACKETS

ST-K4ROT-SH			
	Model	Order nr.	Compatibility
<p>(mm)</p>	Metal top-bottom rotating fixing brackets kit (4 brackets) for SH4	95ASE0042	SH4

ST-KSTD				
	Model	Order nr.	Compatibility	Notes
<p>(mm)</p>	Metal angled fixing brackets kit (4 brackets) for SH4	95ACC1670	SH4, SG2/SG4, SG BODY COMPACT, SG BODY BIG	The angled fixing bracket is included in the package of SH4 but it can be ordered separately for substitutions

ACCESSORIES: TRANSMITTER AND RECEIVER CABLES

SH4 BASE (SH4-**-***-B-**-*)		
Receiver main connector	Length (m)	Order code
CS-A1-03-U-03	3	95ASE1170
CS-A1-03-U-05	5	95ASE1180
CS-A1-03-U-10	10	95ASE1190
CS-A1-03-U-15	15	95ASE1200
CS-A1-03-U-25	25	95ASE1210
CS-A1-03-U-50	50	95A252700
SH4 STANDARD (SH4-**-***-S/SM-**-*)		
Receiver main connector	Length (m)	Order code
CS-A1-06-U-03	3	95ASE1220
CS-A1-06-U-05	5	95ASE1230
CS-A1-06-U-10	10	95ASE1240
CS-A1-06-U-15	15	95ASE1250
CS-A1-06-U-25	25	95ASE1260
CS-A1-06-U-50	50	95A252710
SH4 ADVANCED (SH4-**-***-A-**-*)		
Receiver main connector	Length (m)	Order code
CS-A1-10-U-03	3	95A252720
CS-A1-10-U-05	5	95A252730
CS-A1-10-U-10	10	95A252740
CS-A1-10-U-15	15	95A252750
CS-A1-10-U-25	25	95A252760
CS-A1-10-U-50	50	95A252770
SH4 all models		
Transmitter main connector	Length (m)	Order code
CS-A1-03-U-03	3	95ASE1170
CS-A1-03-U-05	5	95ASE1180
CS-A1-03-U-10	10	95ASE1190
CS-A1-03-U-15	15	95ASE1200
CS-A1-03-U-25	25	95ASE1210
CS-A1-03-U-50	50	95A252700
SH4 all Muting models (SH4-**-***-SM/A-*-5)		
Receiver/Transmitter secondary connector	Length (m)	Order code
CD12M/0B-050B1	5	CD12M/0B-050B1
CD12M/0B-100B1	10	CD12M/0B-100B1

ACCESSORIES: CASCADE CABLES

CS-H2-03-B-**-*		
Model	Length (m)	Order code
CS-H2-03-B-01	1 m	95ASE0031
CS-H2-03-B-03	3 m	95ASE0032
CS-H2-03-B-10	10 m	95ASE0033

Cascade cables have 5 poles, M12 male connector on one side, and M12 female connector on the opposite side. They can be used to cascade SH4 safety light curtains (refer to manual for technical details)

ACCESSORIES: PLUGS

The following are spare parts that can be ordered in substitution of the parts included in SH4 family safety light curtains.

SH-PLUG-**-*			
Model	Main connector	Secondary connector	Order code
SH-PLUG-5	5-pin M12 male	none	95ASE0047
SH-PLUG-8	8-pin M12 male	none	95ASE0048
SH-PLUG-12	12-pin M12 male	none	95ASE0049
SH-PLUG-5-5	5-pin M12 male	5-pin M12 female	95ASE0050
SH-PLUG-8-5	8-pin M12 male	5-pin M12 female	95ASE0051
SH-PLUG-12-5	12-pin M12 male	5-pin M12 female	95ASE0052

ACCESSORIES: SH-TARGET

SH-TARGET			
Model	Description	Order code	
SH-TARGET	Retroreflector target for SH4 BODY alignment	95ASE0046	<p> ■ Removable adhesive area ■ Prismatic reflective area </p>

ACCESSORIES: M12 MALE-MALE ADAPTER

SH-MMA			
Model	Description	Order code	Notes
SH-MMA	M12 Male-Male Adapter	95ASE0044	SH-MMA can be used to convert the SH4 secondary connector (M12 female) in a M12 male, in order to reuse SG muting accessories and cables. It is not needed when using muting accessories designed for SH4.

ACCESSORIES: LASER POINTER

SH-LP			
Model	Description	Order code	Notes
SH-LP	Laser pointer class 2	95ASE0030	SH-LP is a laser pointer with a plastic bracket that can be quickly connected to the profile of SH4 safety light curtains in order to ease the alignment of transmitter and receiver.

(mm)

ACCESSORIES: CABLES FOR MUTING

CV-**-02-B-007			
Model	Description	Order code	
CV-Y4-02-B-007	M12 4-poles T muting cable for SH4	95ASE0037	
CV-L2-02-B-007	M12 4-poles L muting cable for SH4	95ASE0038	

(mm)

ACCESSORIES: SH MUTING CONNECTION BOX

SH-M-CB			
Model	Description	Order code	Order code
SH-M-CB	SH Muting connection box	95ASE0039	The SH-M-CB connection box has 4 M12 connectors on board, one for each muting sensor to be connected to an SH4 light curtain. Unused connectors need to be covered by a cap, in order to maintain IP67 protection. A green LED indicator signals when the muting sensor is generating the corresponding muting signal towards the safety light curtain. Inside the connection box, signals are put in parallel: A1 with A2 and B1 with B2, and forwarded to the pigtail connector, that has to be inserted into the muting connector of the light curtain. This means that muting function of SH4 for which SH-M-CB is compatible are 2-signals T muting and 2-signals L muting.

(mm)

SH4

TYPE 4
SAFETY LIGHT
CURTAINS

